

YDM 3109

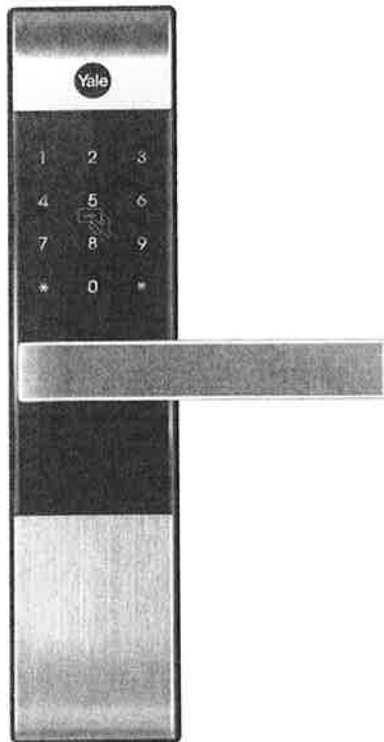

# Digital Door locks

## User Manual

Keep this manual safe for future reference

- ※ The functions and design of this product can be changed without notice for quality improvement.
- ※ Chinese manual is from 33 page. (中文说明书从第33页)

### **Please read the following before using your Yale product**

- This product is designed and manufactured to assure personal safety. Improper use can result in personal damage or property loss. Please observe the procedures for installation, use and servicing.
- Yale is a precision electronic device. All safety and operating instructions should be read before the product is operated.
- Refer all servicing to qualified service personnel. Servicing is required when the product is damaged or to be re-installed.
- Check your installation conditions with the local service provider before installation as your door prep might be different from the standard this lock conforms with.
- The products warranty does not cover defects or damages arising from the door defects, improper installation, lack of or improper maintenance, improper storage, shipping and handling, ordinary wear and tear, misuse, abuse, accident, unauthorized service or use with unauthorized service parts.
- Disassembly, rework and reverse engineering are prohibited without a written approval of Yale except for a normal installation of the product.
- The trademarks, trade names, designs, copyright, patents and other proprietary right used on or embodied in the product and this manual shall remain the exclusive property of the manufacturer, cannot be copied or used in any form without the written authorization by Yale.
- Visit our website [www.yaledigital.com.cn](http://www.yaledigital.com.cn) for more information on the products.
- The information in this manual is subject to change without notice.



# IMPORTANT SAFETY INSTRUCTIONS

Please read the following safety instructions to prevent any accident, property damage and inconvenience. Children should be well educated for the operating instruction. Keep this manual in a convenient place so that you can refer to it when necessary.

**Caution** must be followed to protect yourself and your property.



explains product functions and features.



prohibited



must observe



Yale digital door lock is a precision electronic device.

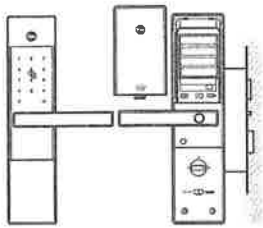

Clean only with dry cloth. Do not use water that can cause damage to the electronic circuit.

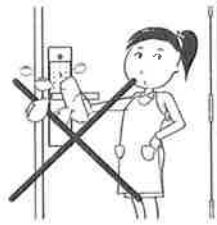

Do not attempt to disassemble the unit by yourself. That can cause an electronic shock and product damage.

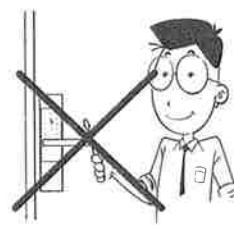

When you move, contact your local service personnel for re-installation. Check the service charge with your service provider.



**Caution**

⊘ Do not use an inappropriate tool that can cause damage or malfunction of the product.

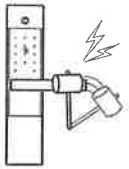

⊘ Handle the unit with care. Excessive force, careless handling may cause product damage.

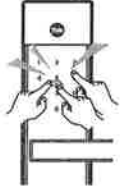

! Be careful not to have an unauthorized user know your security code. Change your code periodically.

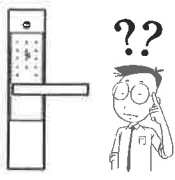

⊘ Do not use water and any type of solvent such as gasoline or benzene as they can cause damage to electronic circuit, deterioration and/or paint peel-off.

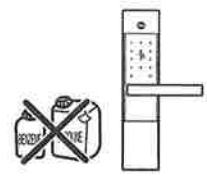

! Do not have your card key lost or stolen.  
■ Immediate re-registration of all remaining keys is required to invalidate the lost key.

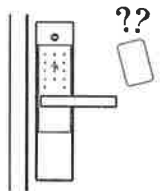

! Educate your children about the proper use of the product.



! Make sure the door is securely locked whenever you leave your house, especially in the manual lock mode.

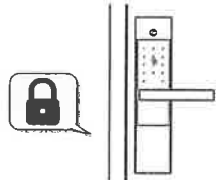

! Make sure the distance between the door and door frame is not widened more than 5mm.

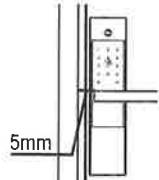

! Keep card key reader part clean and dry. Dust off dirt smoothly with a soft cloth.



! Remove all of the batteries before installing or removing a remote control module.



# I Overview

## ■ Proximity card identification

You can use your ISO 14443 A type RFID card such as credit card or pass card as your card key.

## ■ Triple access

You can unlock the door by the card, the security code or the mechanical key at your convenience. You do not need to worry about accidental lockouts by losing or forgetting the key.

## ■ Easy re-registration of keys

If you lose a key, you can invalidate the lost key by re-registering all other keys. You can register up to 40 card keys to add users.

## ■ Anti-collision

Contacting multiple cards does not cause error to the lock. The card key reader will recognize the card key among a pack of cards.

## ■ Easy and simple operation

One-touch operation allows every user including children and senior the simplest use.

## ■ Automatic locking

Just closing the door will automatically lock the door. Manual operation is also available.

## ■ Break-in / Damage alarm

80dB alarm will go off if anyone attempts to damage the lock or forces the door open.

## ■ Safe handle

Protects from any break-in attempts through the safe handle.

## ■ Verification with the palm

The security code is verified by palm touching to randomize any fingerprint residues on the keypad so protect from exposing it.

## ■ Emergency power supply

When the batteries are completely discharged you can easily supply emergency power to the lock with the 9V battery.

## ■ Volume control

You can change the volume. The break-in alarm still operates even if the silent mode is on.

## ■ Forced lock mode

Internal forced lock prevents anyone to unlock from the outside and external forced lock makes only manual thumbturn available to open the lock from the inside.

## ■ Remote control

You can use a remote control by installing the applicable Remote control module. (This option may not be available depending on your country or local dealer.)

## ■ Smart Pad

Keypad displays functional operation with lighting.

## Basic Operation

**⚠ Please do remember below operation!**

### 1. Card Key Registration



### 2. Security Code Registration

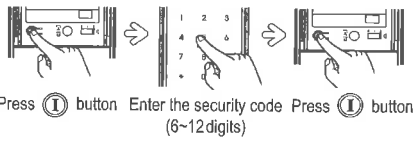

### 3. Locking the door from the outside

- The automatic Lock Sensor detects the door closing and locks the door within 5 seconds, or
- Touch the keypad with palm for locking the door in **M** [Manual Lock Mode]

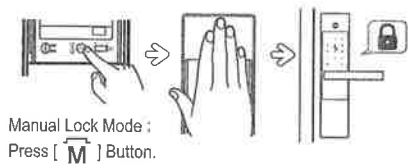

### 4. Unlocking the door from the outside

- Contact Card key
- Wake up the lock with the palm touch, enter the security code and retouch the lock with the palm.



### 5. Automatic / Manual Lock Mode

- Automatic Lock Mode :  
Press **A** Button
- Manual Lock Mode :  
Press **M** Button

### 6. Forced Locking

- Forced Lock Mode from inside.
- Forced Lock Mode from outside.  
With the palm    Contact 5 seconds    or    Contact **#** 3 seconds after put security code

### 7. Volume control

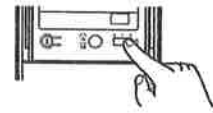

- Mute : [Volume] Button
- Normal : [Volume] Button
- Loud : [Volume] Button

### 8. Turning off the alarm





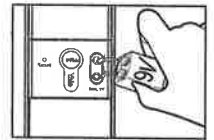

- Contact the card key on [card key reader], or
- Enter the security code, or
- Press and hold **I** button for 5 seconds

### 9. Emergency power supply

9V Battery can be used to supply electricity to the unit.



# CONTENTS

 <b>Specifications</b> .....	08	 <b>Option</b>	
 <b>Identification of Product</b> .....	09	1. Remote control module .....	27
 <b>How to use</b>		2. Remote control .....	28
1. Registering Card Keys .....	11	 <b>Cautions</b>	
2. Registering Security Code .....	13	1. Emergency power supply .....	30
3. Locking the door from the outside .....	14	2. Lost card key .....	31
4. Unlocking the door from the outside .....	15	3. Product malfunction .....	31
5. Locking the door from the inside .....	17	4. Emergency mechanical key override .....	32
6. Unlocking the door from the inside .....	17	 <b>Chinese Manual (中文简单说明书)</b> .....	33
7. Enabling/disabling Safe handle .....	18		
8. Automatic / Manual Lock Mode .....	20		
9. Forced Lock Mode .....	21		
10. Break-in / Damage alarm .....	22		
11. Wrong-try Lock-out .....	23		
12. Volume control .....	24		
13. Battery use & Replacement .....	25		
14. Displaying operation status (Smart Pad) .....	26		

# 1 Specifications

Parts		Specifications	Remarks
Front (Front Body)		68.6(W) x 306.6(H) x 27(D)(70.6)mm, Zinc die-casting	Operating temperature : -15~55°C (5~131 °F)
Back (Main Body)		72.8(W) x 306.6(H) x 37.0(D)(80.8), Flame-Retardant ABS, Zinc D/C	
Lever		Zinc die-casting	
Card Keys		4 EA	Up to 40 keys (sold separately)
Battery		4EA 1.5V AA alkaline batteries (Operating voltage: 4.5 ~ 6 V)	Last up to 10 months (10 times used a day)
Lock case		Steel and SUS304	
Option	Remote Control	Wireless	Optional

\*Battery life may vary depending on temperature, moisture levels, frequency of use and the quality of the batteries.

\*Please make sure that all parts are included when purchasing the product.

\*Optional products may not be available depending on your country or local dealer.

## ■ Basic Contents

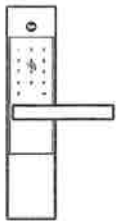

Front (Front Body)

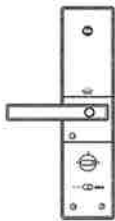

Back (Main Body)

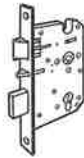

Lock case

- 4 Card keys
- Emergency keys
- Screws
- Installation Template
- 4 Batteries
- Users Manual

## ■ Option

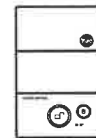

Remote control



Remote control module



# 2 Identification of Product

## 1. Front (Front Body, install on the outside of the door)

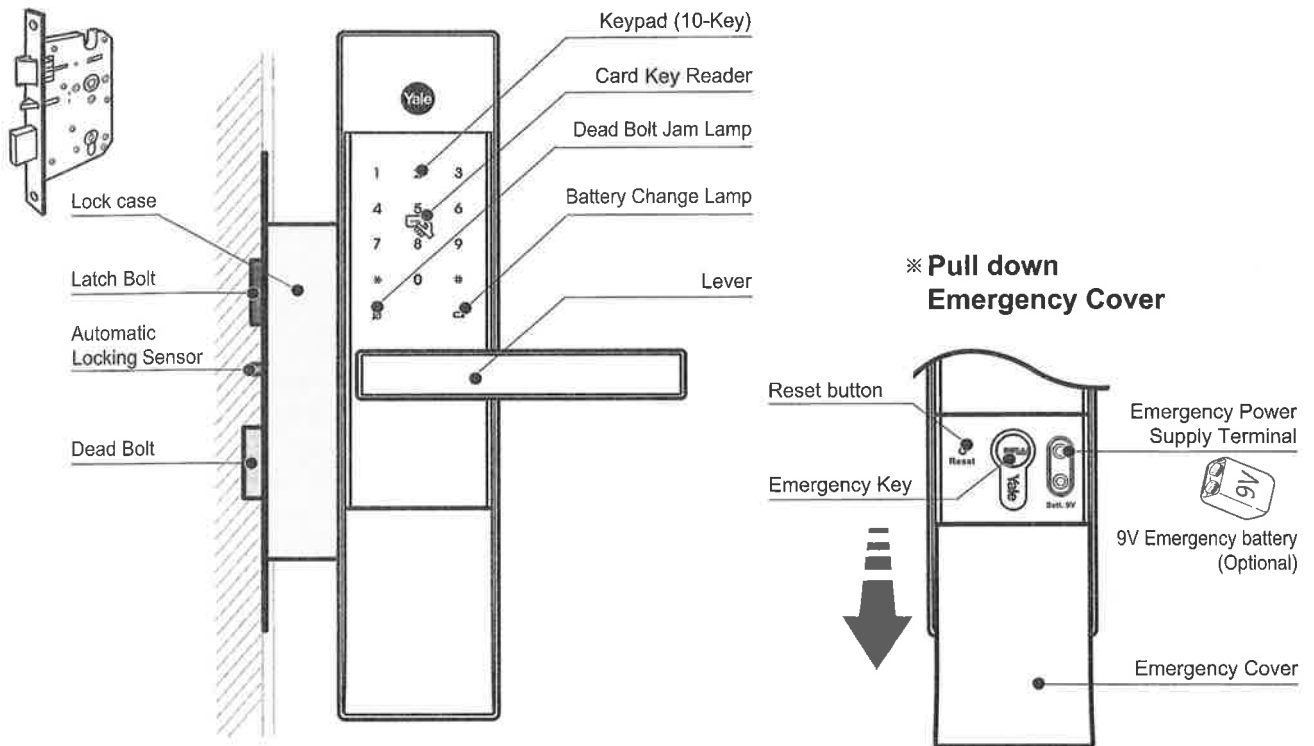

## 2. Back (Back Body, install on the inside of the door)

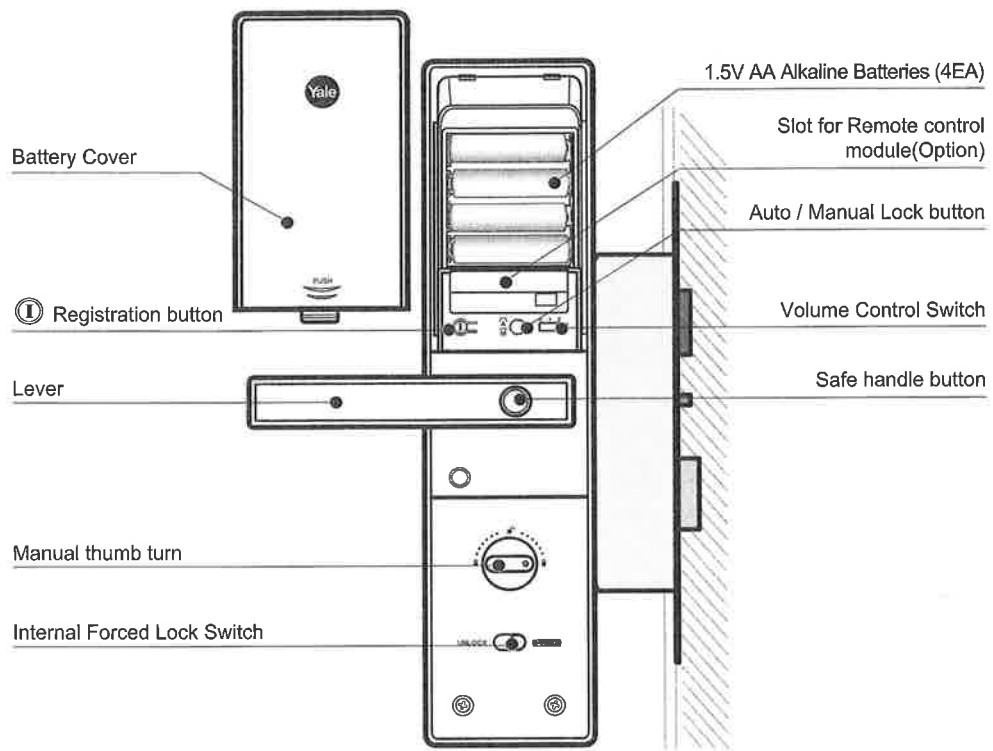

# 3 How to Use

## 1. Registering Card Keys

### ⚠ Caution

- Keep the door open while you register card key to prevent yourself from accidentally getting locked out.

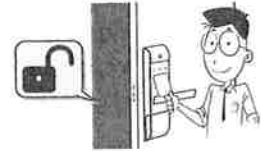

### Note

■  Additional maximum  
Basic 4 keys + 36 = 40

4 card keys are provided at purchase and you can register up to 40 card keys.



Contact your local dealer for additional card keys.



If you lose your current card key, re-register all the remaining keys to invalidate the lost key.



ISO 14443 A type RFID card can be registered as your card key.

⚠ All card keys should be registered at a time.

1

Press **I** [Registration] button

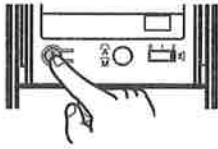

Open [Battery Cover] and Press **I** [Registration] button.

If it takes too long (over 7 seconds) to contact a card key after pressing **I** [Registration] button, the card will not be registered.

2

Contact all the card keys you wish to register on the [card key reader] one by one

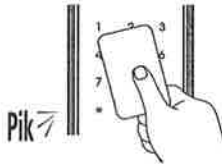

If you hear a "pik" sound, the card keys are registered. If you hear a "ti-to-ti-to" sound, the card key had been already registered.

- The numbers of registered cards are shown on the keypad.

3

Press **I** [Registration] button

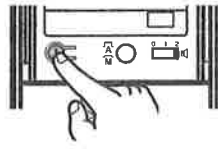

The registration is completed with a "pi-bi-bing" sound.

4

Check the key operation



Opening the door with your card key. Contact your card key to [card key reader]

**Opening the door with your card key**

Touch the keypad with the palm ⇨ Contact card key

## 2. Registering Security Code

### ⚠ Caution

- Keep the door open while you register the security code to prevent yourself from accidentally getting locked out.

### Note

- (6 digits) (12 digits) Set a code of 6~12 digits using the number buttons  
000000 ~ 000000000000
- The old code is automatically deleted when registering a new code.

1

Press ① [Registration] button

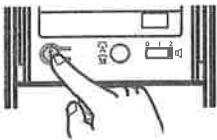

Open [Battery Cover] and Press ① [Registration] button.

⚠ If it takes too long (over 7 seconds) to enter the code after pressing ① [register security code] button, the code will not be registered.

2

Enter your security code

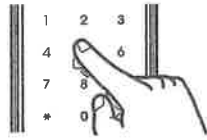

Enter the code you wish to register. (6~12 digits)

⚠ < \* > and < # > buttons can not be used for security codes.

3

Press ① [Registration] button

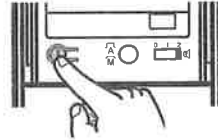

The registration is completed with a "pi-bi-bing" sound.

- When registering the security code, it shows what the user has just registered in order.

4

Check your security code

Once registration is completed, make it sure to open the lock with your new security code.



**Opening the door with your code**

Touch with the palm [keypad]  
↔ Enter security code ↔  
Touch with the palm [keypad]

### 3. Locking the door from the outside

※ Please check Automatic / Manual Lock Mode

Automatic lock mode

The automatic lock sensor detects the door closing and locks the door automatically within 5 seconds.

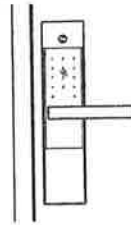
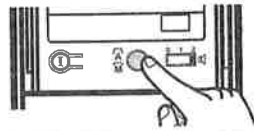

Within 5 seconds



Manual lock mode

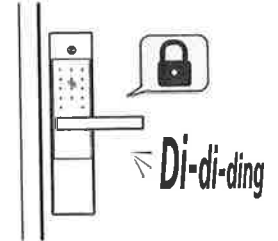
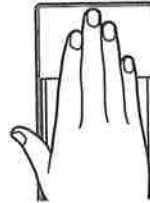
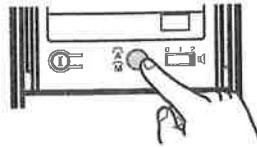

The door locks when touch the keypad with the palm.



#### ⚠ Caution

As the automatic lock function does not work in manual lock mode, make sure to check that the door is securely locked when leaving the premises.

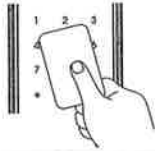
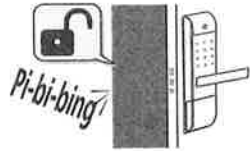
## 4. Unlocking the door from the outside

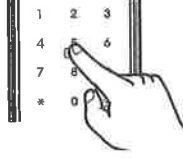
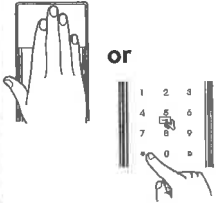
Unlocking the door with card key	<b>1</b> Contact card key 	<b>2</b> Confirming the door open 	
	<b>1</b> Touch the keypad with the palm 	<b>2</b> Enter your security code 	<b>3</b> Touch the keypad with the palm again or press * button 



- The keypad cannot be operable in case of wearing the glove.
- Using the palm or pressing \* button do the same function after entering the security code.
- If the card key does not work properly, please contact the card key after touching the keypad with the palm.

## Opening the lock by the fake PIN code

- This explains how to open the lock with the fake PIN code.

Opening the lock by the fake PIN code

**1**

**Touch the keypad with the palm**



Please slightly touch the exterior keypad.

**2**

**Press any number (fake PIN code) and the right PIN code**

Fake PIN code → Right PIN code  
or  
Right PIN code → Fake PIN code



**Caution**

- This feature is not working when the lock is locked down due to wrong-try lock-out delay.

**3**

**Touch the keypad with the palm or press \* button**

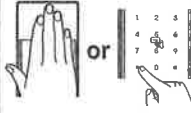

Please slightly touch the exterior keypad or press \* button to finish.

**4**

**Confirming**



*Pi-bi-bing*

The lock is unlocked with melody ("Pi-bi-bing")

### Caution

- When any incorrect PIN codes are inputted five times in a row, it turns the lock down for three minutes.
- When this function is on, the user cannot use the fake PIN code function until any normal verification through key, card, fingerprint, PIN code, or opening the lock from inside is made. So, the user is encouraged to use the right PIN code without any fake number to verify the lock.

### Note

- Use the fake PIN code feature whenever there is any chance of exposing the right PIN code to others.

16



## 5. Locking the door from the inside

### Automatic lock mode

When set on automatic lock mode, the automatic lock sensor detects the door closing and locks the door automatically within 5 seconds.

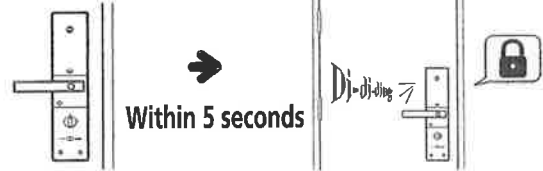

### Manual lock mode

Use [manual thumb turn] on the back body.



## 6. Unlocking the door from the inside

### Down the lever while pressing the Safe handle button

① Down the lever while pressing the Safe handle button

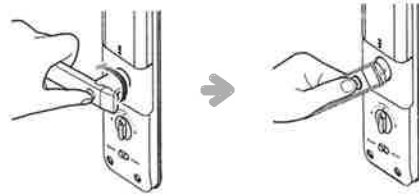



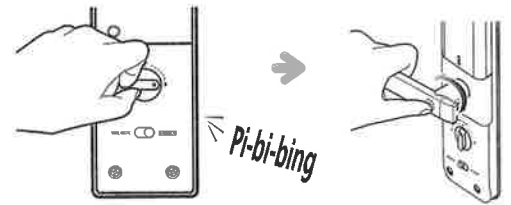

② Turn the manual knob

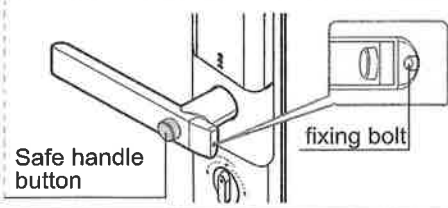
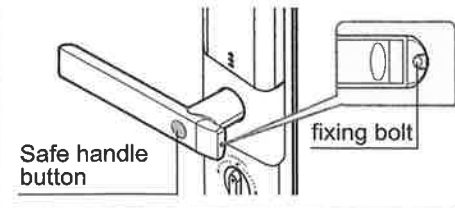

## 7. Enabling/disabling Safe handle

YDM3109 protects from any break-in attempts through the Safe handle button.

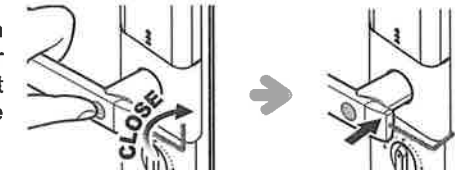
Factory default : Enabled status

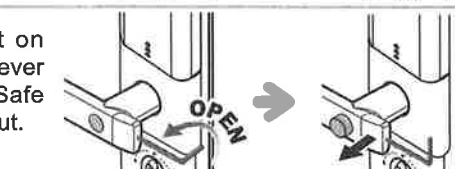
<b>Enabled status</b>		<b>Disabled status</b>	
<b>Disabling Safe handle</b>	<p>Take out the hexagon wrench which is docked in the battery cover.</p> <p>The hexagon wrench</p> 	<p>Turn the fixing bolt on the side of the inner lever to the right while pressing the Safe handle button.</p>	
<b>Enabling Safe handle</b>	<p>Take out the hexagon wrench which is docked in the battery cover.</p> <p>The hexagon wrench</p> 	<p>Turn the fixing bolt on the side of the inner lever to the left until the Safe handle button pops out.</p>	

### **⚠ Caution**

Be careful not losing the fixing bolt when you loosen it to set the feature on.

**Egressing when the Safe handle egress button is on**

**1** Down the lever while pressing the Safe handle egress button

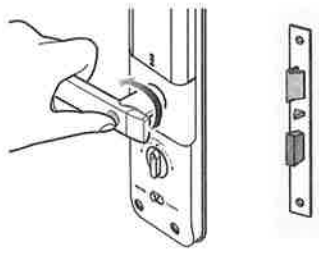

**2** Example

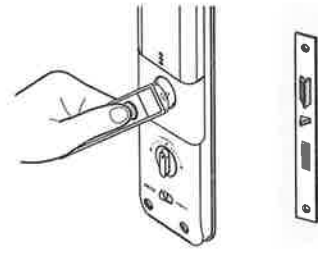

**▲ Caution**

- The locking bolt would not be retracted in case of not pressing the button.
- When the fire detection sensor is on, the feature is still on so the user must follow the usual procedure to open the door.

## 8. Automatic / Manual Lock Mode

Automatic locking sensor which detects the door closing and automatically locks the door in 5 seconds. Automatic lock mode is a factory default setting.

Setting it on automatic lock mode

Push up the Button on **A** Mode.

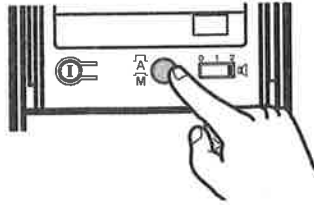



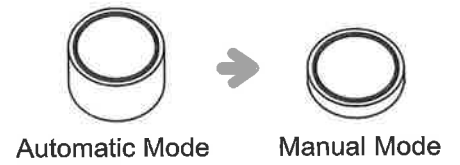
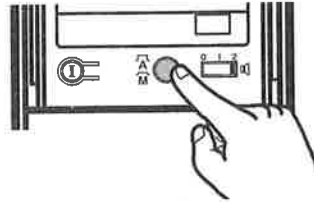

Setting it on manual lock mode

Push down the Button on **M** Mode.

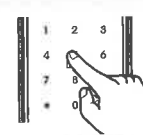
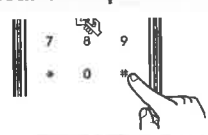

## 9. Forced Lock Mode

### External forced lock mode

<p>① Setting external forced lock mode on with the card key</p>	<p>1 <b>Contact card key</b> Contact the card key on [card key reader] for 5 seconds until you hear 3 beeps.</p>  <p>5 seconds <i>piik piik piik</i></p>	<p>2 <b>Confirming external forced Lock</b> External forced lock mode is set on with "Di-ri-ric" sound.</p> 		
<p>② Setting external forced lock mode on with the security code</p>	<p>1 <b>Touch the keypad with the palm</b></p> 	<p>2 <b>Enter the security code</b></p> 	<p>3 <b>Press # button for 3 seconds until you hear 3 beeps</b></p> 	<p>4 <b>Confirming external forced Lock</b> External forced lock mode is completed with "Di-ri-ric" sound.</p> 

### Internal forced lock mode

When internal forced lock mode is on, the keypad is not functioning.

A warning beep sound will go off if anyone attempts to verify by the security code or the card from outside.

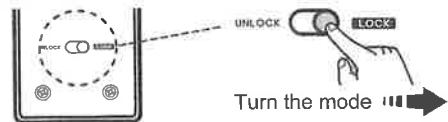

## 10. Break-in/Damage alarm

80dB alarm goes off when the lock is damaged or anybody breaks in by force while the door is locked.



### Turning off the alarm

(Choose one of the four options below.)

Enter your security code

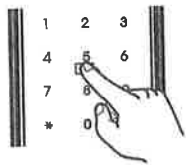

or

Contact your card key

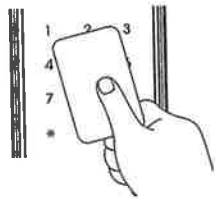

or

Press and hold **I** [Registration] button for 5 seconds

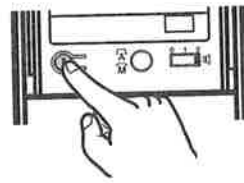

or

Press **U** [Unlock] button on the remote control

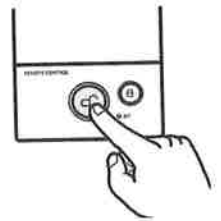

## 11. Wrong-try Lock-out

No keypad function is available during this wrong-try lock-out delay. The break-in and damage alarm work regardless of this function.

- If incorrect security codes or unregistered card keys are attempted 5 times in a row, it will lock out for about 3 minutes with the blinking LED.

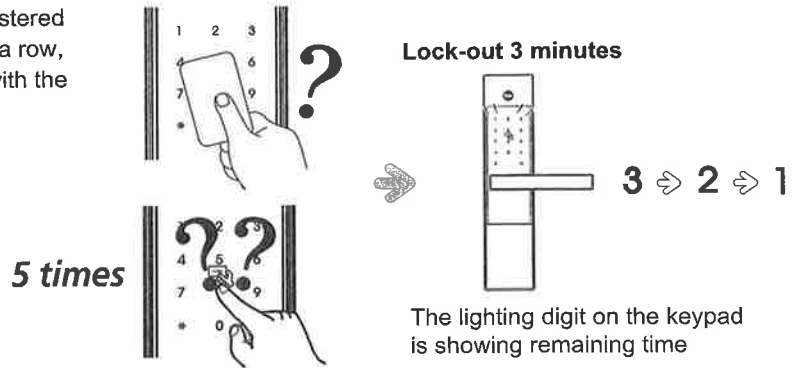

- The system will resume the operation automatically after 3 minutes of lock-out. If you press  [Registration] button on the back body or down the lever while pressing the Safe handle egress button, it resumes the operation.

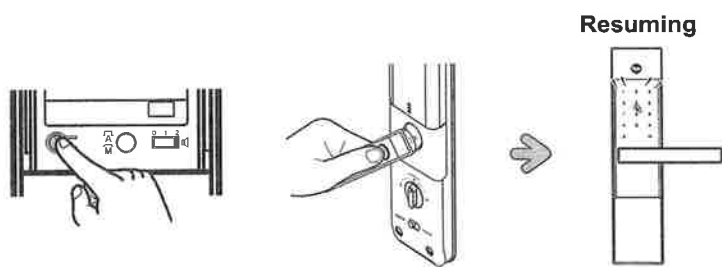

## 12. Volume control

This function can control the operating sounds so that the door can be opened and closed without disturbing others.

### ① Silent Mode

Setting the volume Button on "0"

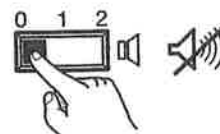

### ② Normal Mode

Setting the volume Button on "1"

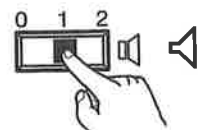

### ③ Loud Mode

Setting the volume Button on "2"

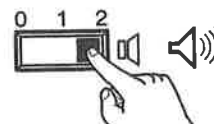



# 13. Battery use & Replacement

## ■ Battery life (stand alone)

This product uses 4 1.5V alkaline AA batteries which can be used approximately 10 months on the condition of 10 times open/close cycles per day.

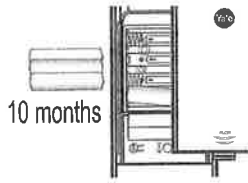

1.5V AA size alkaline battery

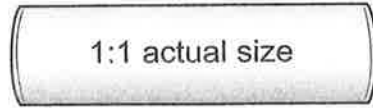

※ Battery life may vary due to temperature, moisture, frequency of use, and the quality of the batteries.

## ■ Battery replacement warning

Replace all 4 batteries when the low battery warning melody rings and the LED turns red. (Use authentic alkaline batteries)

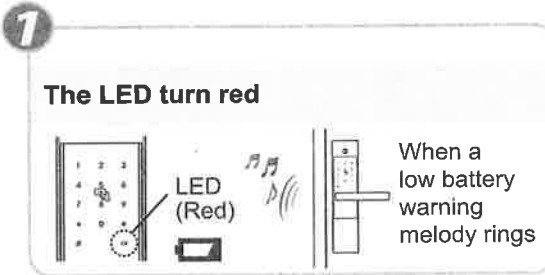

### ▲ Caution

- Always check + and - directions when inserting batteries.
- Use the authentic alkaline batteries. It is a user's responsibility for damage caused by using unauthentic batteries.
- Dispose of used batteries according to the instructions.

※ **RISK OF EXPLOSION IF BATTERY IS REPLACED BY AN INCORRECT TYPE.**

**DISPOSE OF USED BATTERIES ACCORDING TO THE NATIONAL CODE OR RECYCLING PROGRAM.**

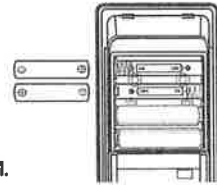

# 14. Displaying operation status (Smart Pad)

## 1 Battery Replacement warning

 Battery Icon lights on.



## 4 External / Internal forced locking

Starting from the left column, the LED comes on from left to right to left for twice.

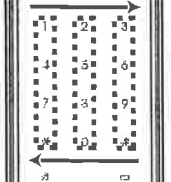

## 2 Dead Bolt locking motion warning

 Locking Icon lights on.



## 5 Break-in / Damage warning

The LED keeps coming on to the clockwise when a break-in or damage is happened. (Alarm lasts for 30 minutes)

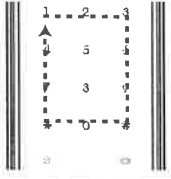

## 3 Wrong-try Lock-out warning

If incorrect security codes or unregistered card keys are attempted 5 times in a row, it will lock out for about 3 minutes with the blinking LED.

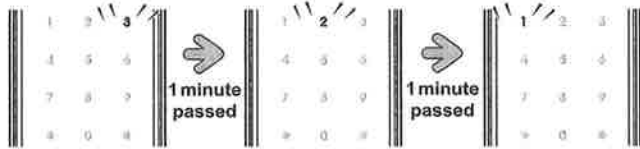

Wrong-try Lock-out warning starts

3 → 3 minutes remaining

2 → 2 minutes remaining

1 → 1 minute remaining

## 6 Security Code registration

When registering the security code, it shows what the user has just registered in order.

(Right : In case of registering 1, 2, 3, 4, 5 and 6)



## 7 Card Key registration

When registering the card keys, Keypad displays the number of registered card keys.

(Right : 3 is on → 3 keys have been registered)

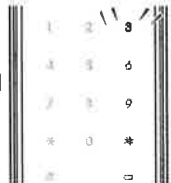

# 4 Option

## 1. Remote control module

Remote control module should be installed in advance to use remote control. Open [battery cover] and insert the module into the slot. Proper functioning of the module can be checked by operating a remote control.



- Remote control module :  
Required for the use of  
remote control

### Installing remote control module

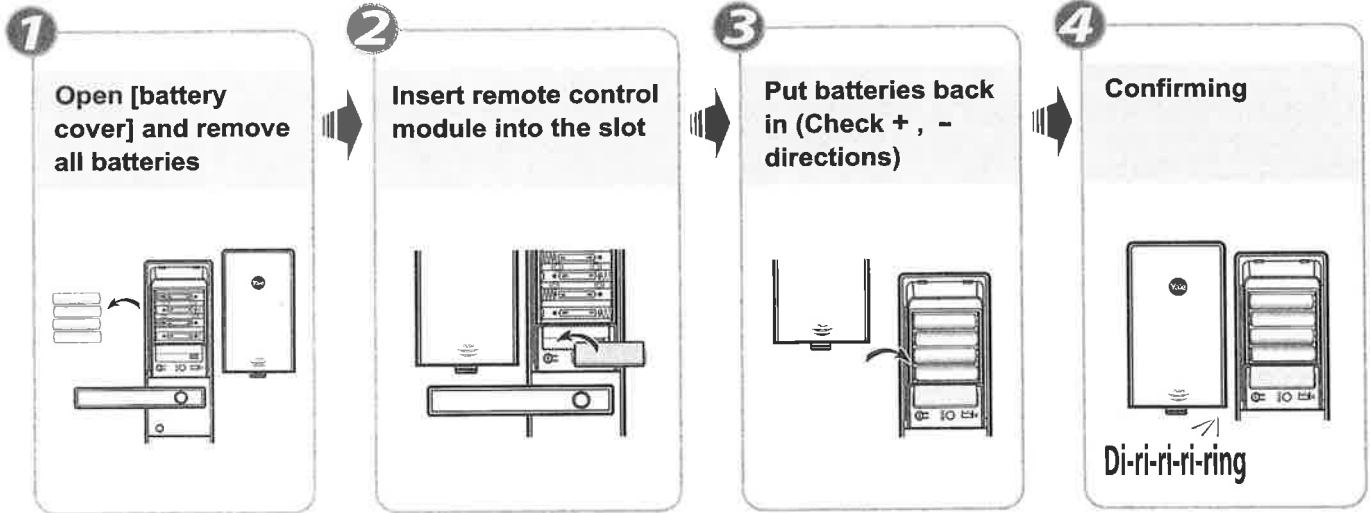

## 2. Remote control

The remote control is an FSK(Frequency Shift Keying) type that uses a Floating ID encoding system, which changes the wireless code each time you use it, so that there is no risk of hacking. It is non-directional and the operational range is up to 10~20m.

※ **Caution!** The operational range may vary depending on the installation environment.  
Re-registration automatically deletes the previous registered remote control.

### Registering remote control

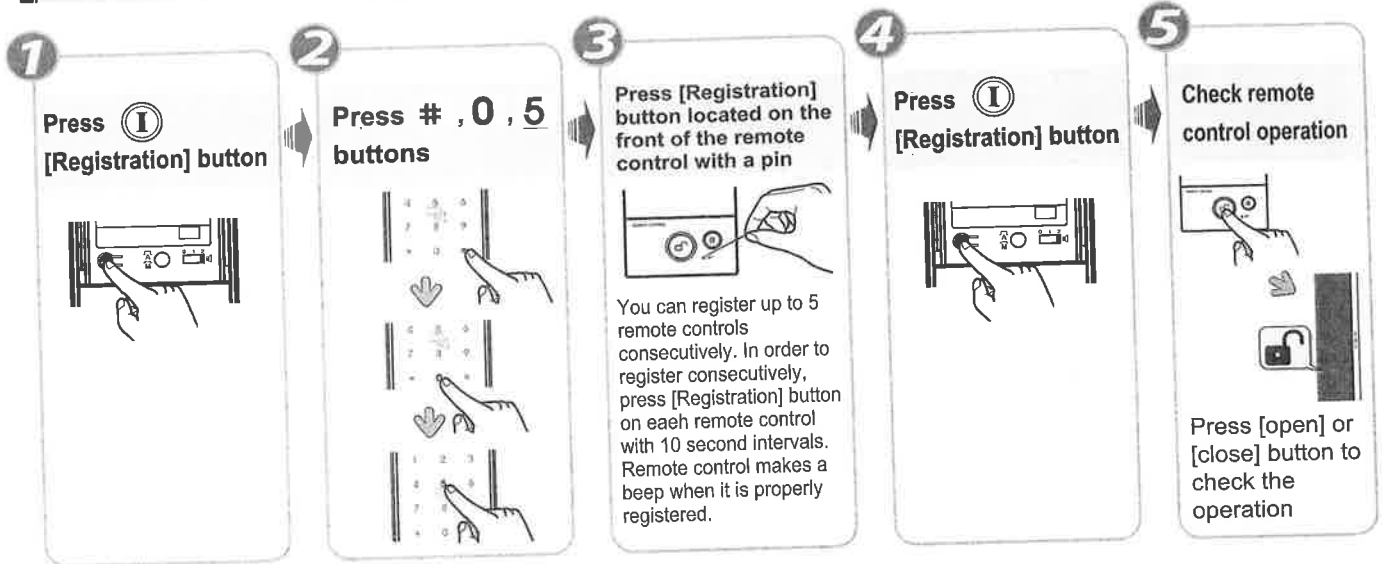

## Deleting remote control registration

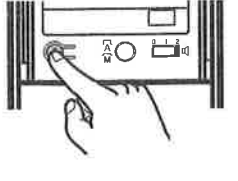
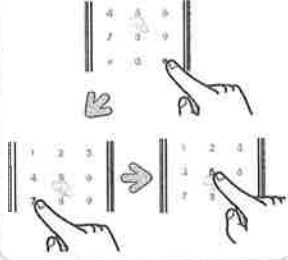
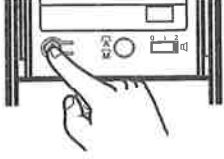
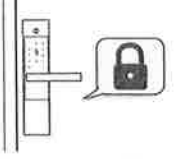
- 1** Press **I** [Registration] button  

- 2** Press **#**, **7**, **5** buttons  

- 3** Press **I** [Registration] button  

- 4** Deleting remote control registration  

Remote control registration is cancelled with a "di-ri-ring" sound.

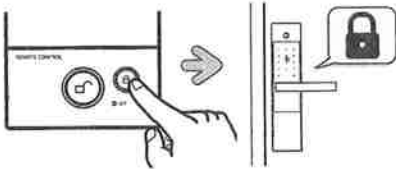
## How to use the remote control

### Locking the door

Press **B** [close] button, and the door will lock within 2~3 seconds.



### Unlocking the door

Press **C** [open] button, and the door will unlock within 2~3 seconds.

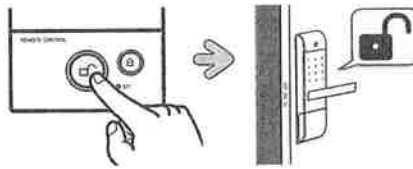

### Changing the batteries

Open up the battery cover at the back of the remote control and change the batteries.

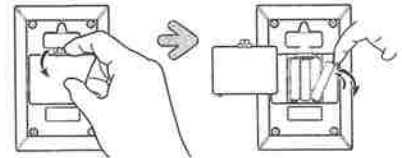

# 5 Cautions

## 1. Emergency power supply

In case the batteries are completely discharged 9V battery can be used to supply electricity to the unit. Unlock with the card key or security code while contacting a **9V battery** just like the below instruction. Discharged batteries should be replaced right away.

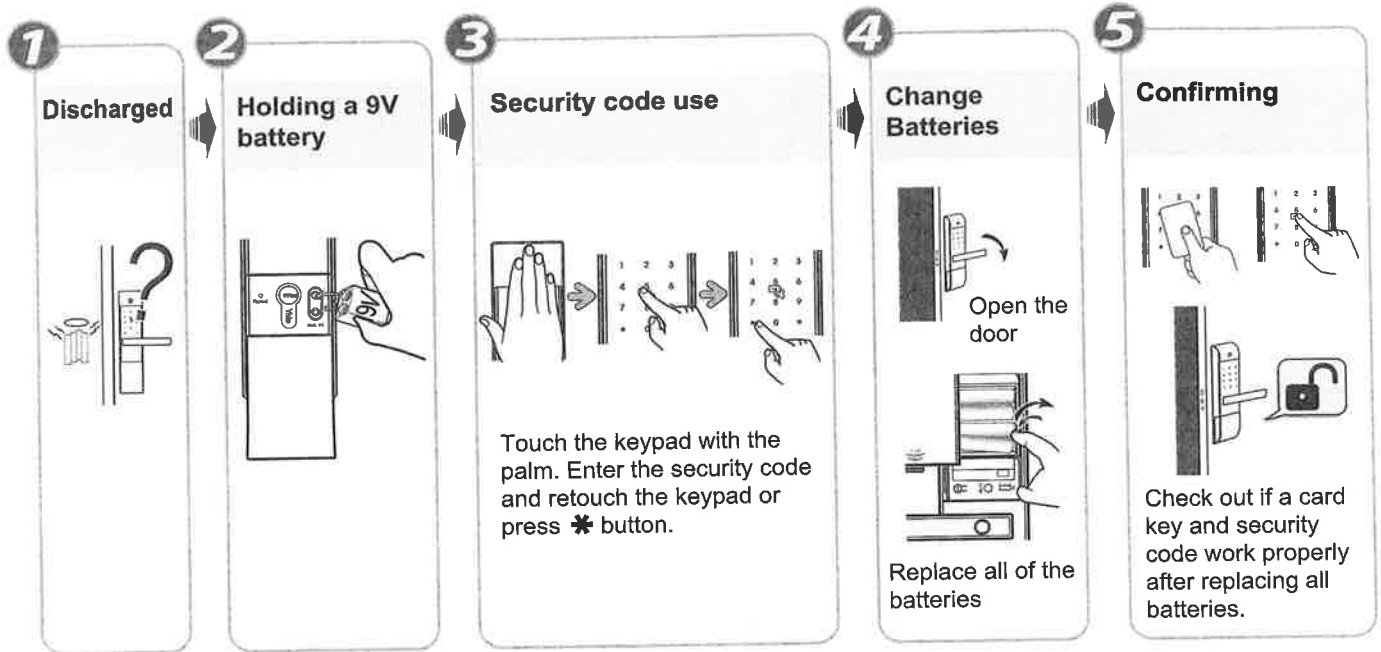

## 2. Lost card key

If you lose your card, rest of card keys must be re-registered to invalidate missing one.

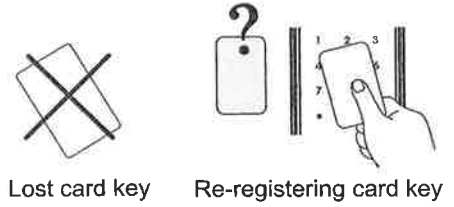

### ⚠ Caution

Enter the security code in case you lose the card key or you are not carrying it.

※ It is a user's liability to break the lock because the user did not register any security code.

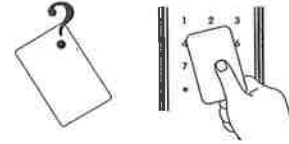

## 3. Product malfunction

Press reset button located in the left of [emergency power terminal] with a pin and try again with the key or the security code.

If it still does not work, call for after-sales service.

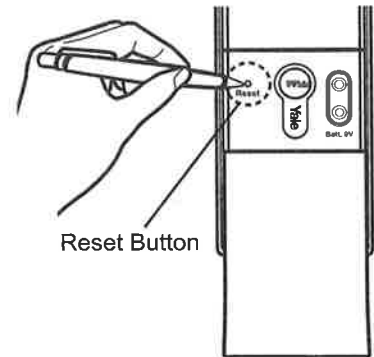

## 4. Emergency mechanical key override

Please operate the lock with the mechanical key when there is a problem to the lock or unlock the door that is the same as below listed.

- Forgotten security code
- Electronic malfunction

※ Please slide the cover downward

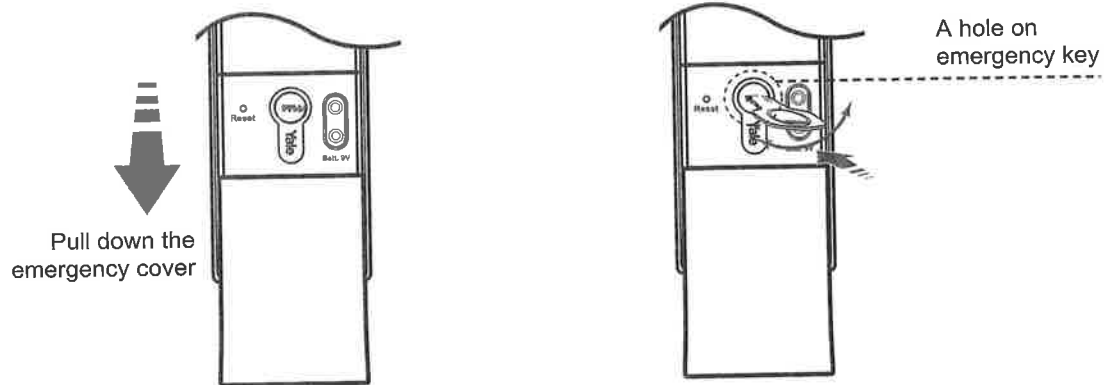

### ⚠ Caution

- Keep the mechanical override key in a safe place. Otherwise, you may not get a free after-sales service even within during the warranty period.